

### This document contains 16 A4 pages.

- Print out all of the pages at 100%. Do not 'scale to fit'.
- Use the test square below to ensure printing at the correct size.
- You will need glue/tape and a pair of scissors or a craft knife.
- Each page is numbered at top left. There is a 20mm overlap between the pages where glue can be applied.
- Using the crop marks at the edge of each sheet, match up the pages as diagram, right.
- You may wish to trim off the excess at the edges of each sheet.
- When complete, cut out the pattern pieces along the outer, seam allowance edge.
- Pin to fabric of your choice, cut out and assemble.

### Order of assembled pages

1,1	2,1	3,1	4,1
1,2	2,2	3,2	4,2
1,3	2,3	3,3	4,3
1,4	2,4	3,4	4,4

↑ 20mm overlap

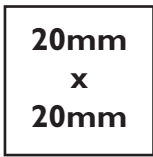

#### Print Size Test Square

When printed, the square at left should measure exactly 20mm x 20mm. If not, check your print settings and ensure that you're printing each page at 100% with no 'scaling'.

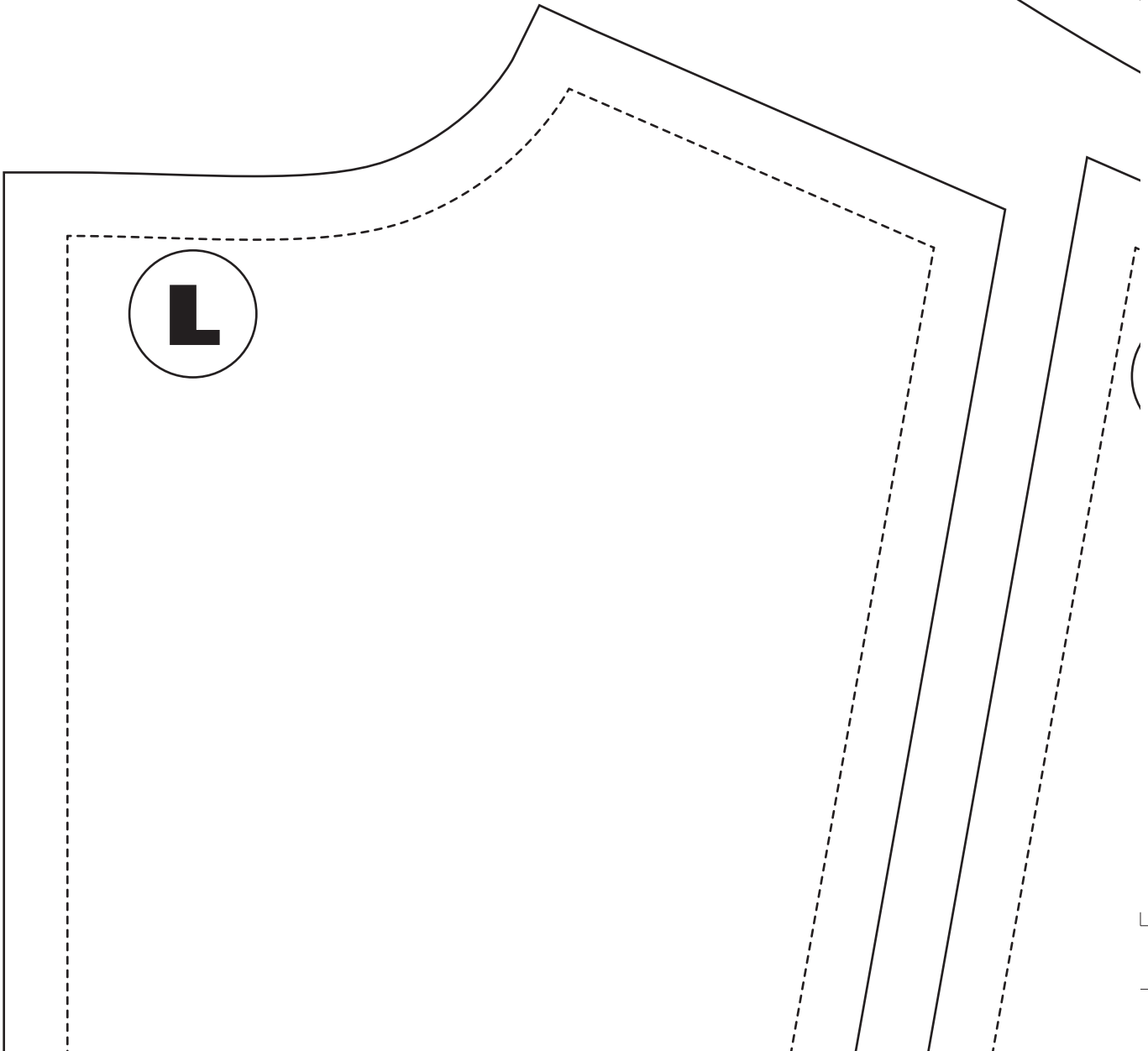
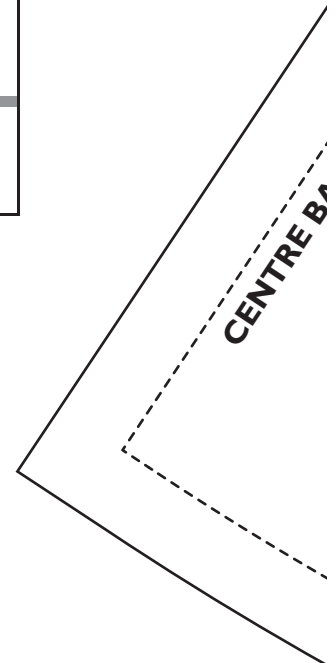

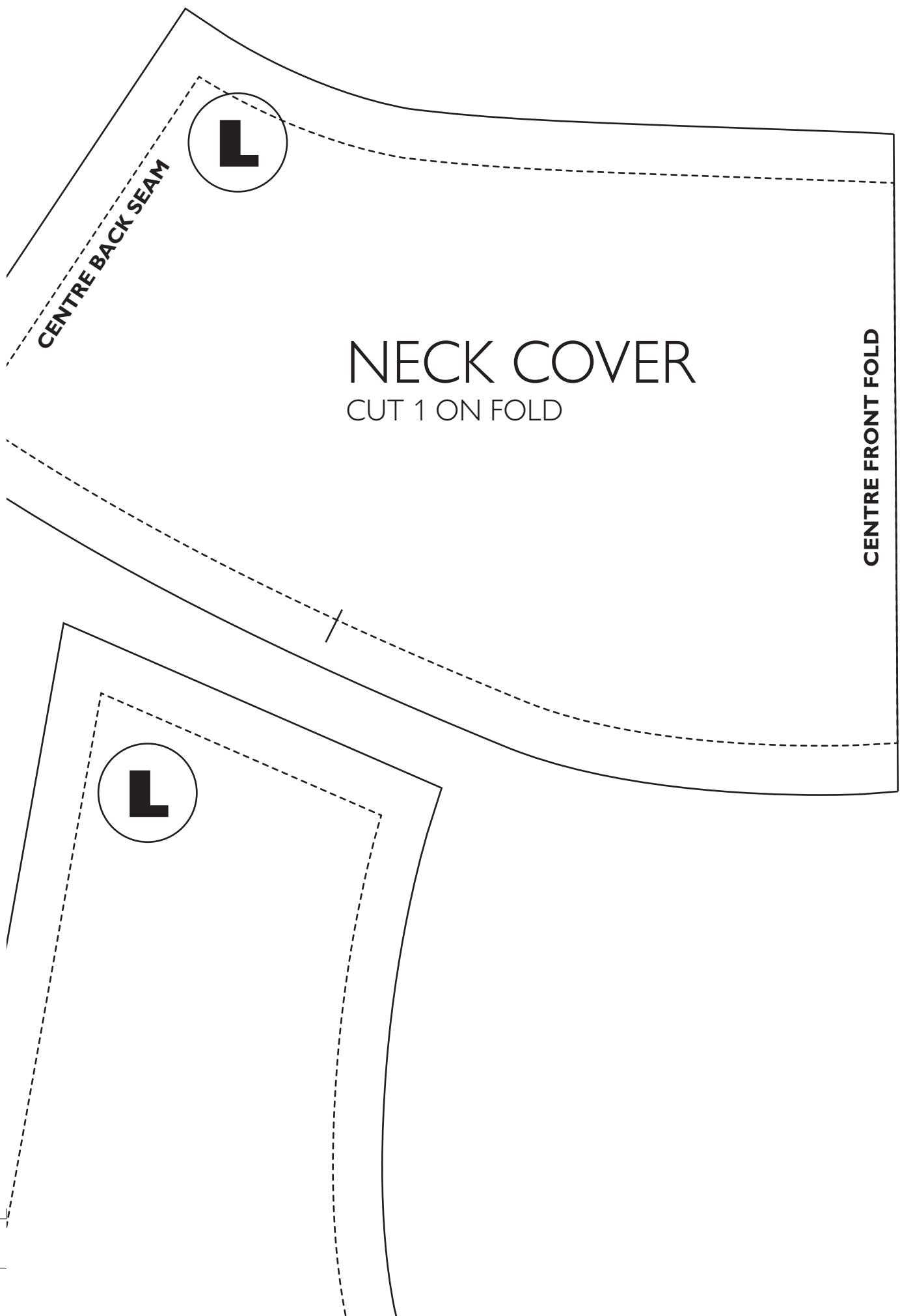

CENTRE BACK SEAM

L

# NECK COVER

CUT 1 ON FOLD

CENTRE FRONT FOLD

L

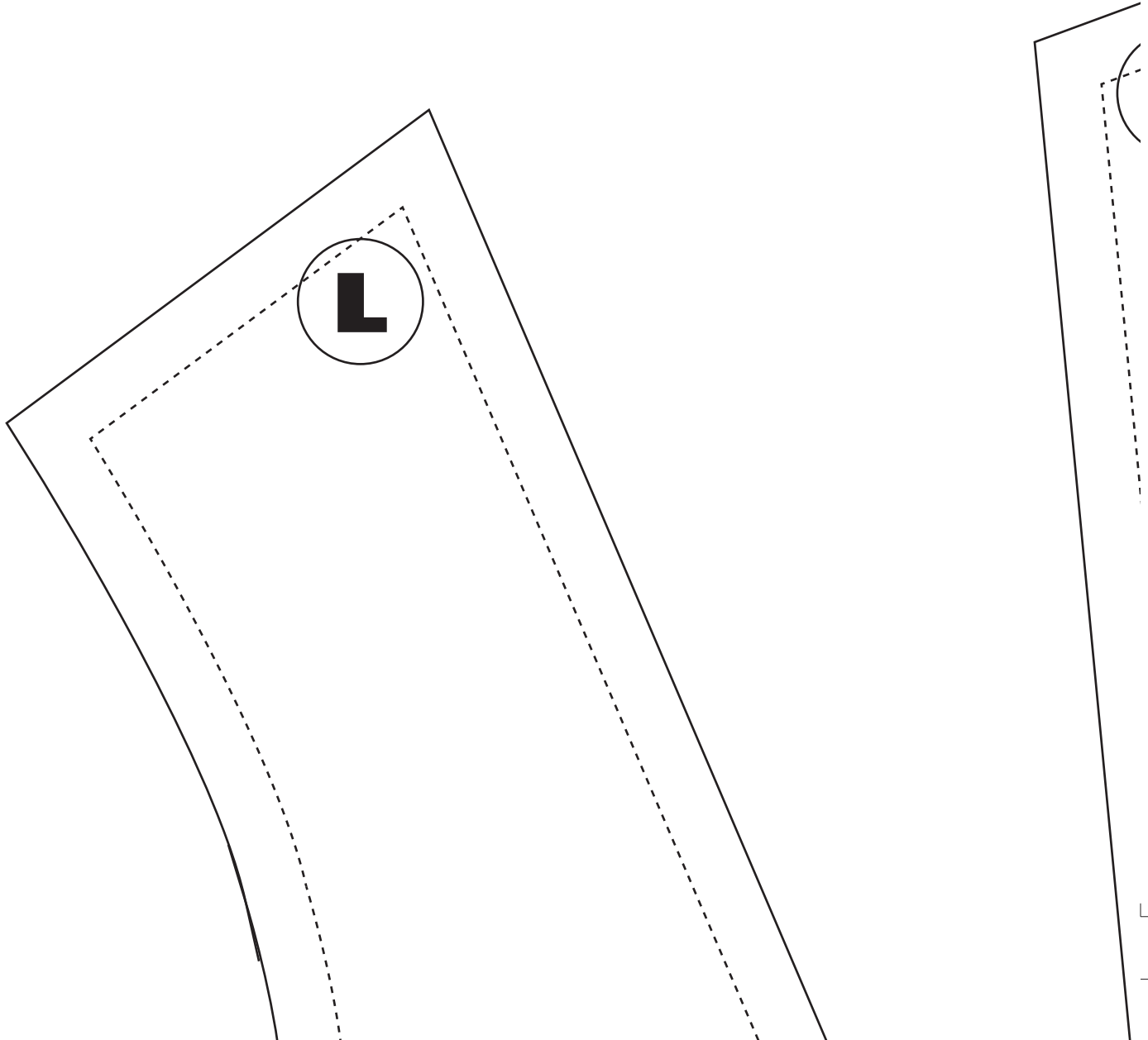
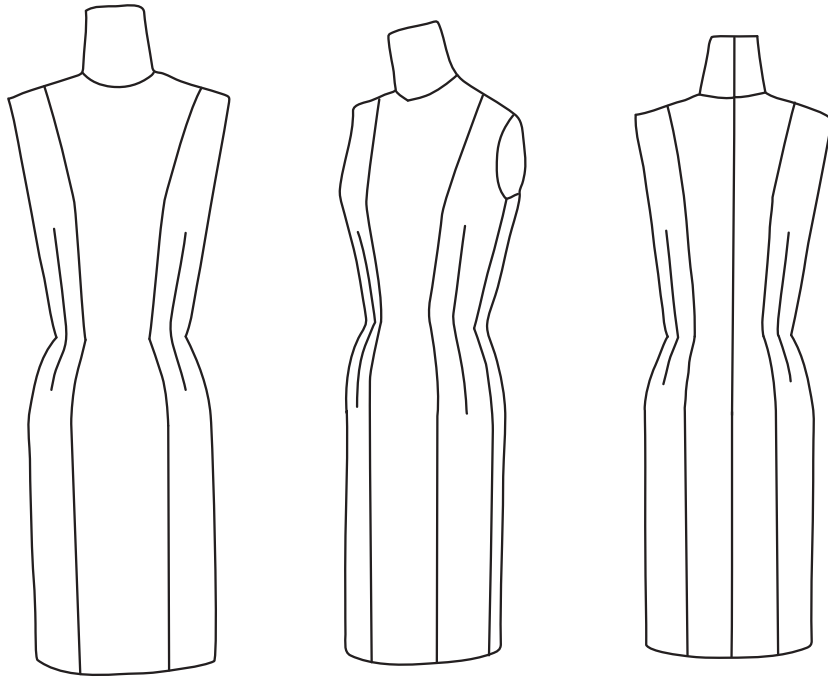



# Shoben Flatpack Dress Stand



1cm seam allowances added

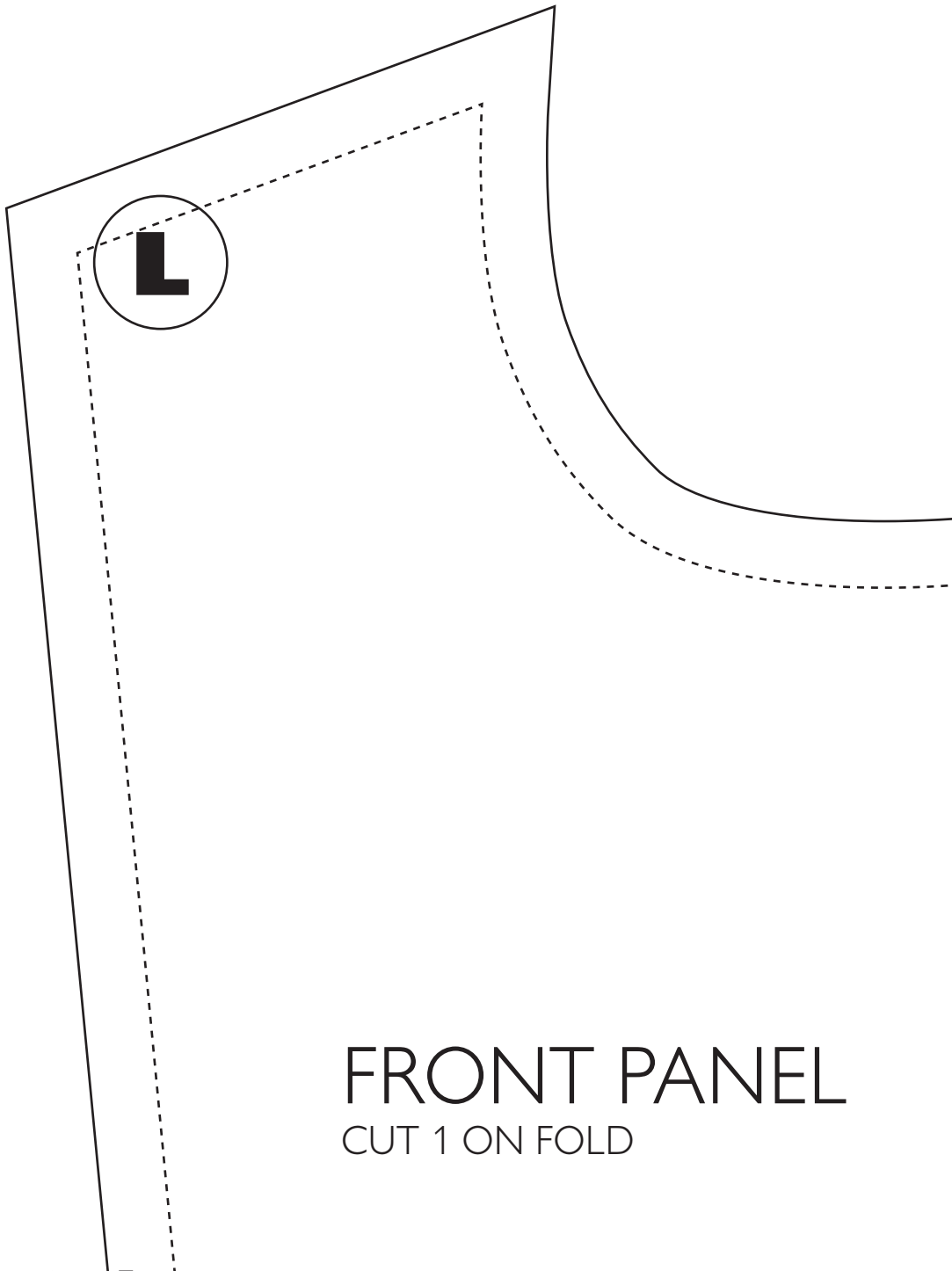

**FRONT PANEL**  
CUT 1 ON FOLD

# CENTRE BACK PANEL

CUT 2

CENTRE BACK SEAM

SII  
CUT

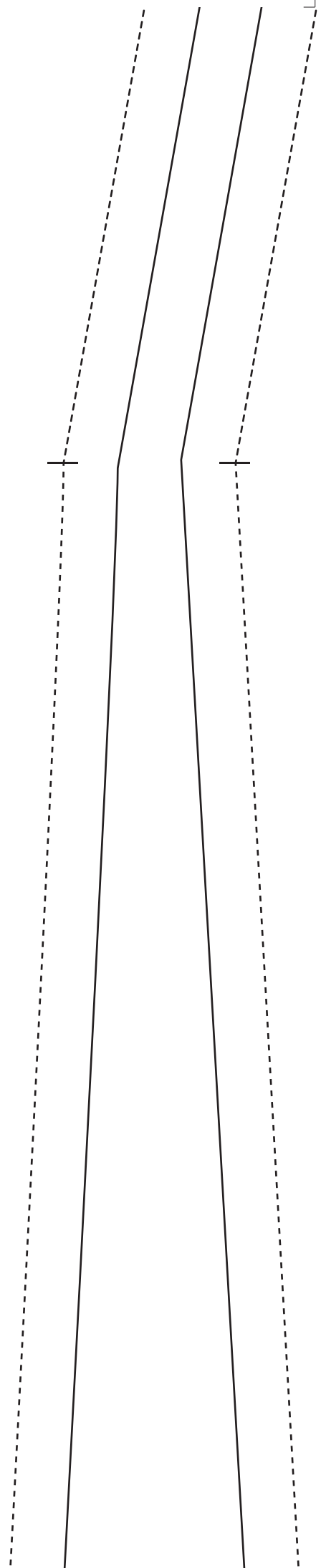

# SIDE BACK PANEL

CUT 2

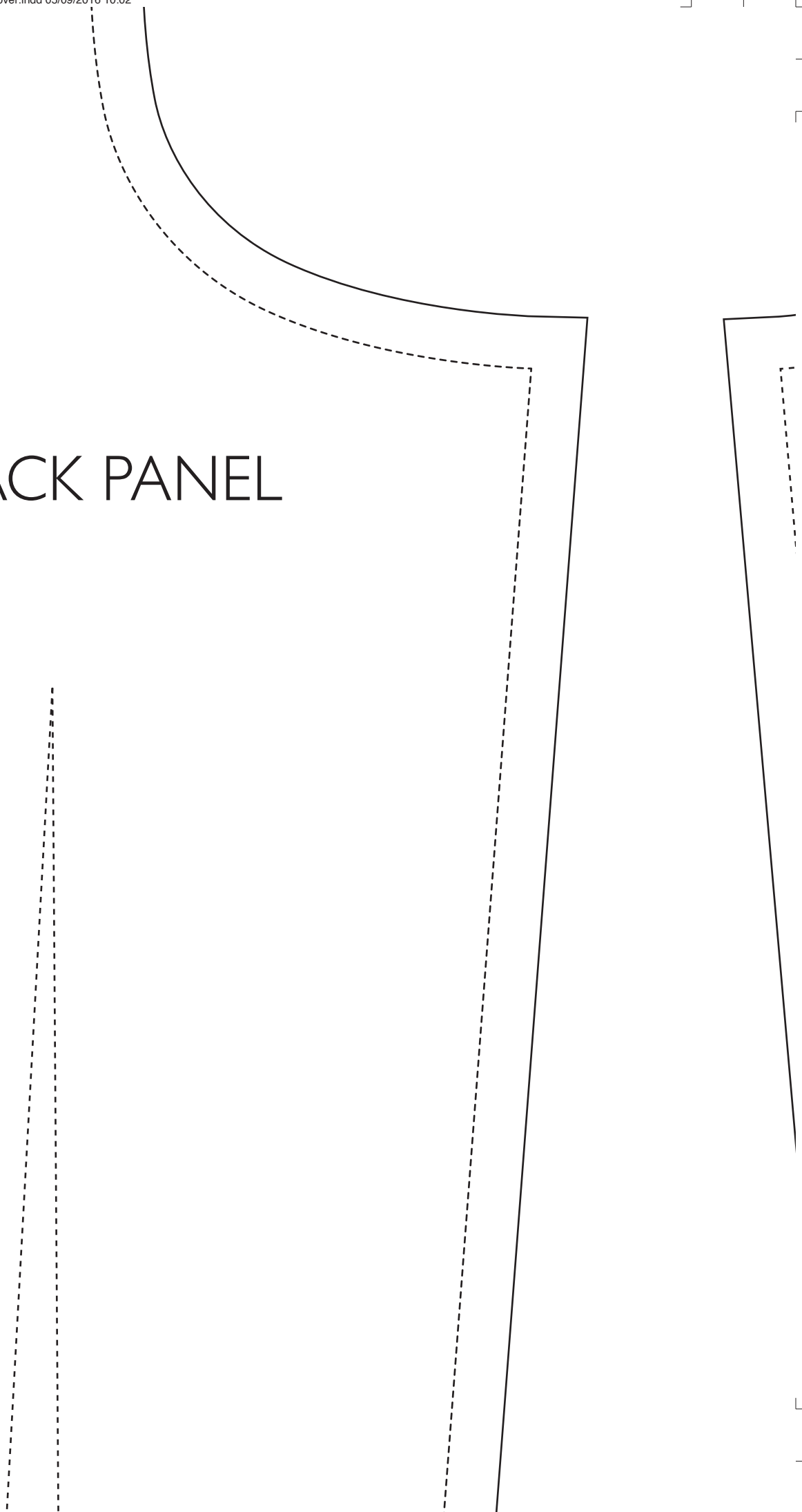

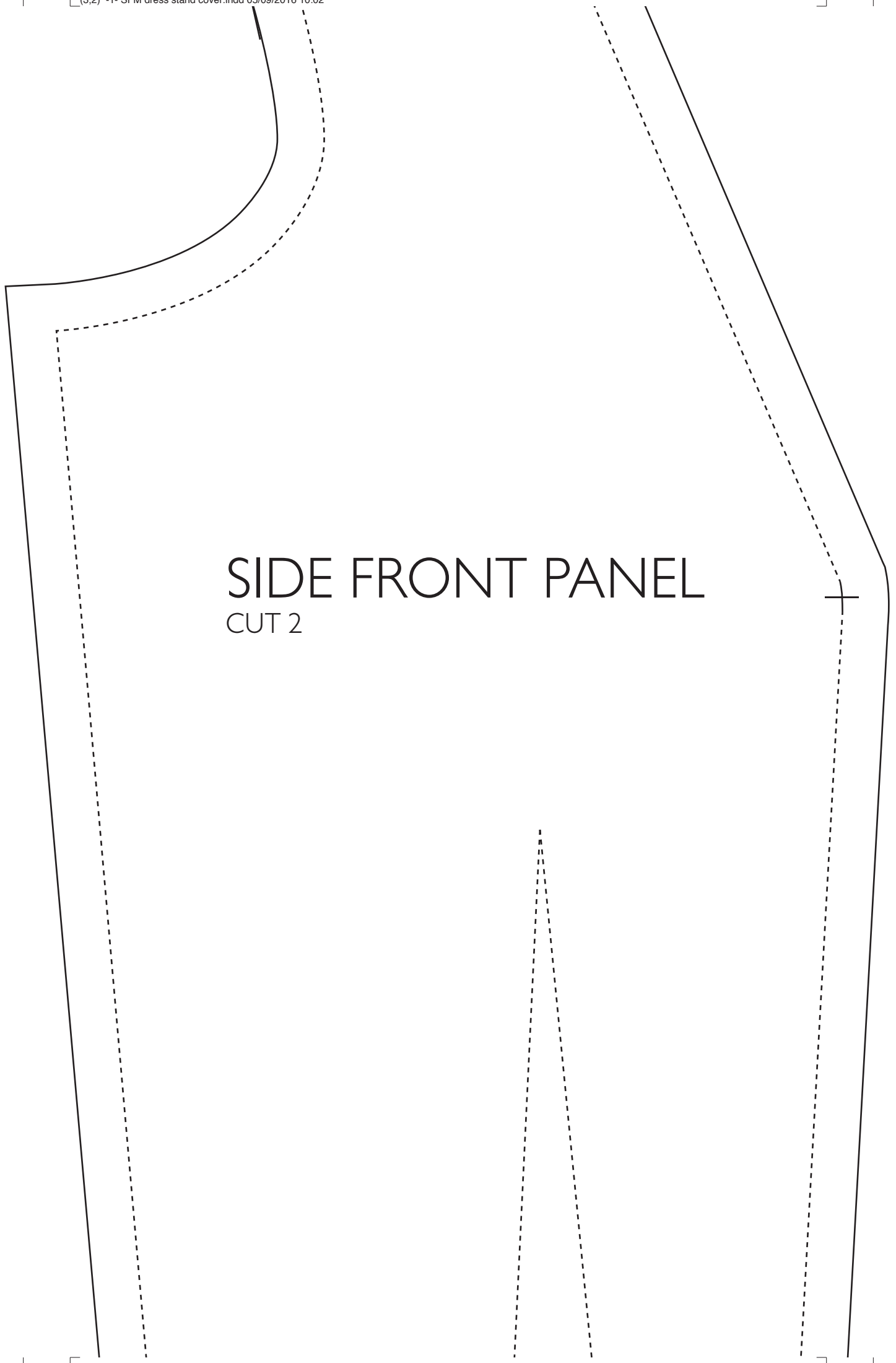

# SIDE FRONT PANEL

CUT 2

CUT TO IN FOLD

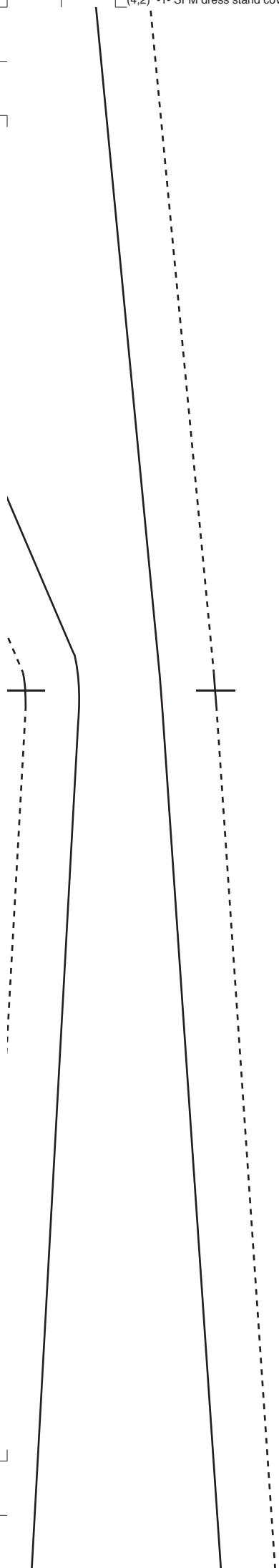

**CENTRE FRONT FOLD**



**CEN**

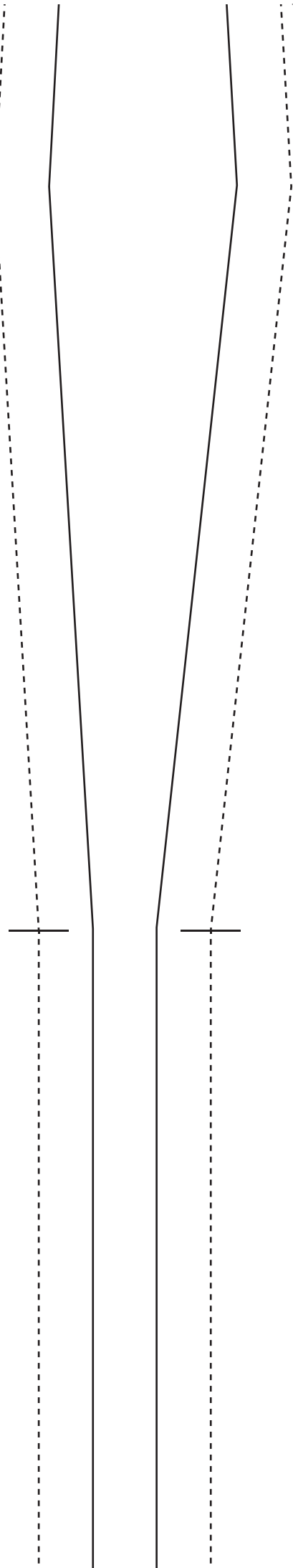

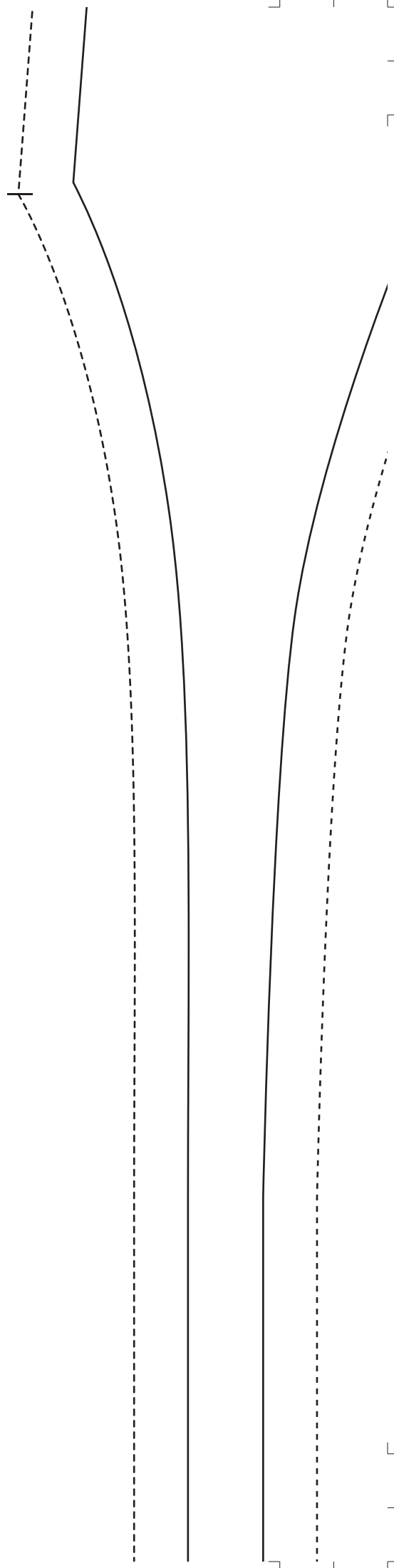

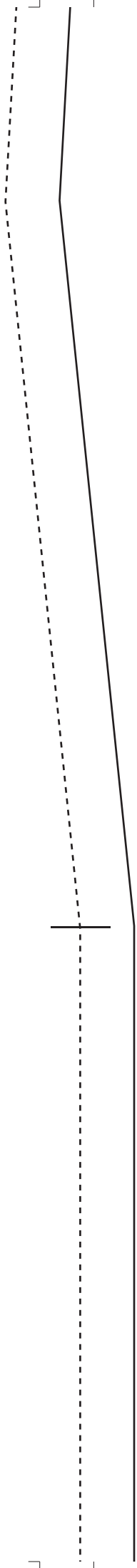
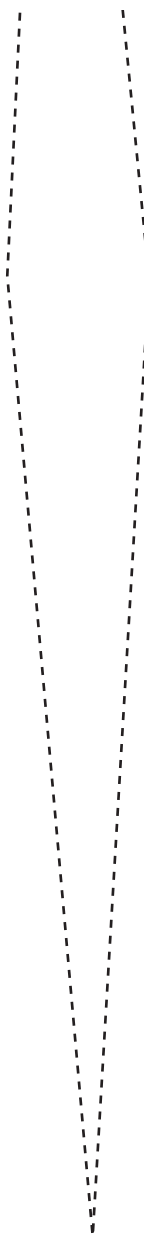
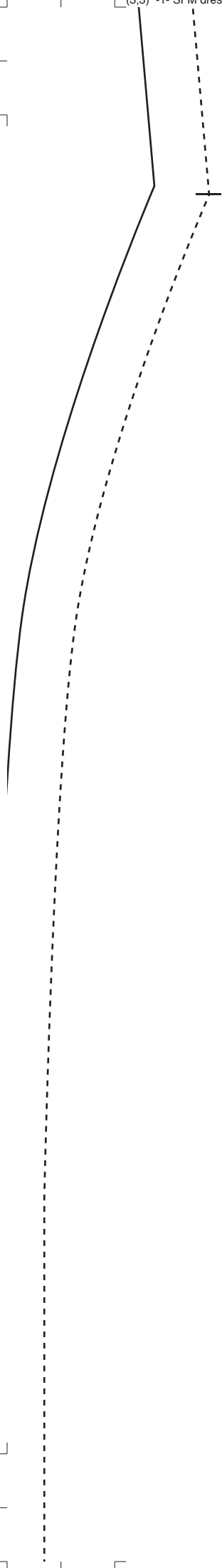

CENT

